

* -

HunterDouglas 
Architectural

Drwg.No. C-i-SMe-PI-Beta Hook on Safetyloop-Folded 2D_Application A	Date: 19.08.2019	Scale: 1:5
	Size: A3	Rev: -
Subject: Ceiling Interior Stretch Metal Planks Beta Hook on Safetyloop Folded		

**Stretch Metal Plank Beta Hook-on
Folded 50 Al / Fe**

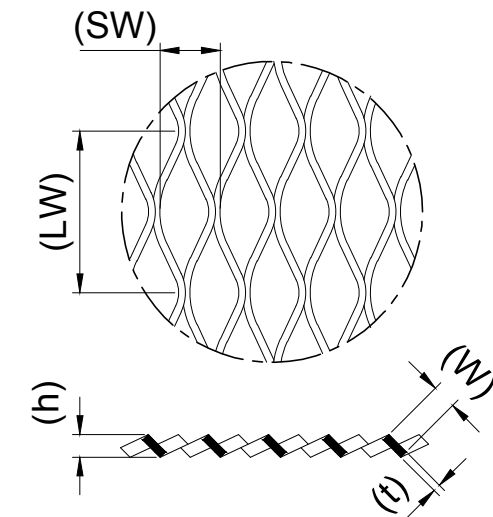
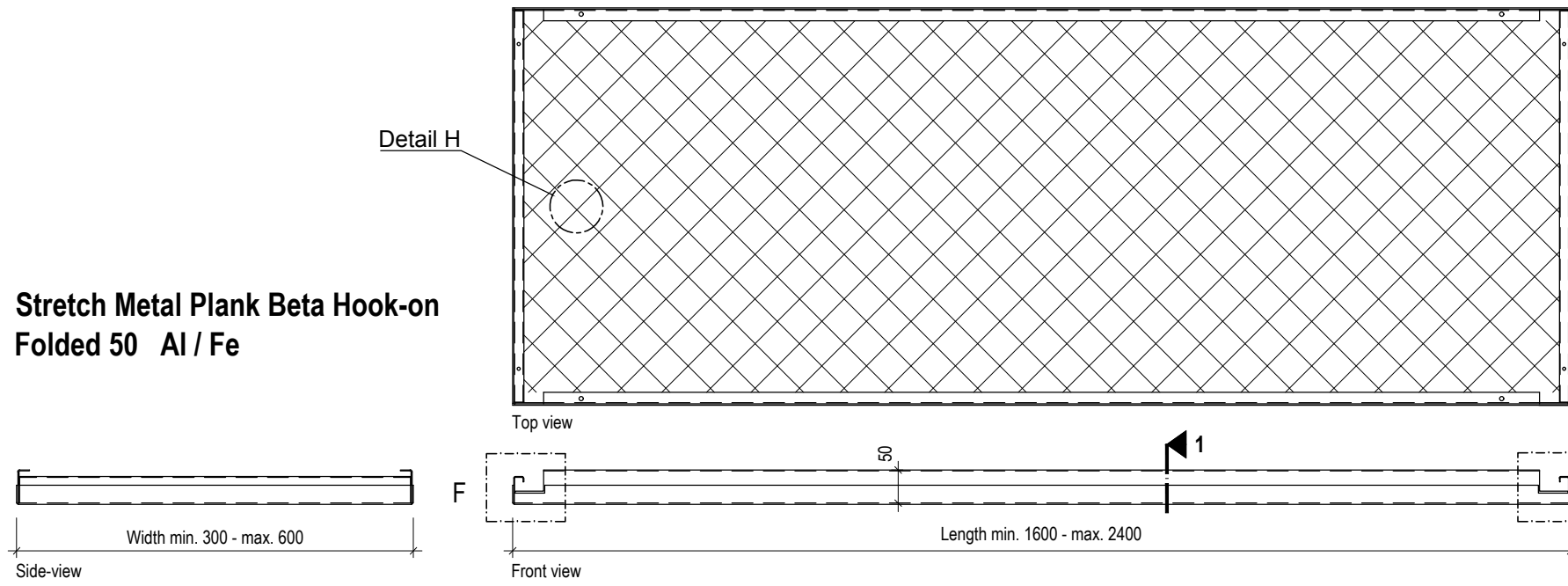

Detail H scale -:-
Orientation stretch metal
For dimensions see brochure

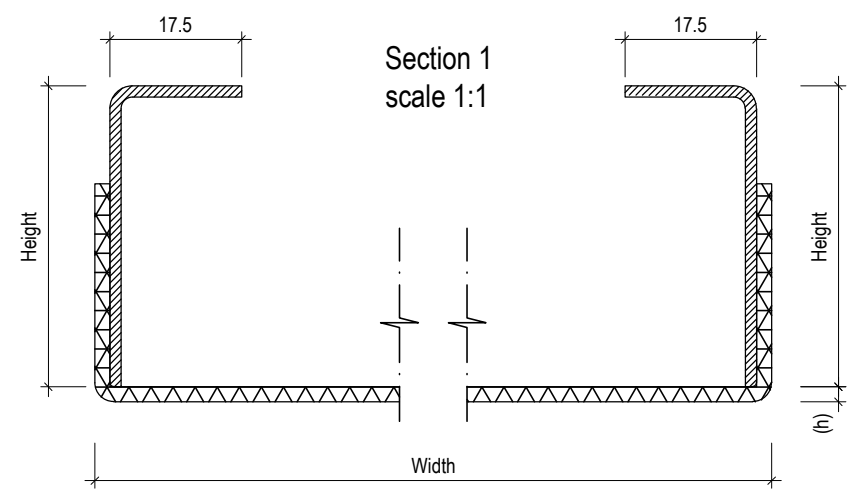

Width from	Width to	Length from	Length to	Height
300	600	800	1200	30
300	600	1200	1600	40
300	600	1600	2400	50

**Stretch Metal Plank Beta Hook-on
Folded 40 Al / Fe**

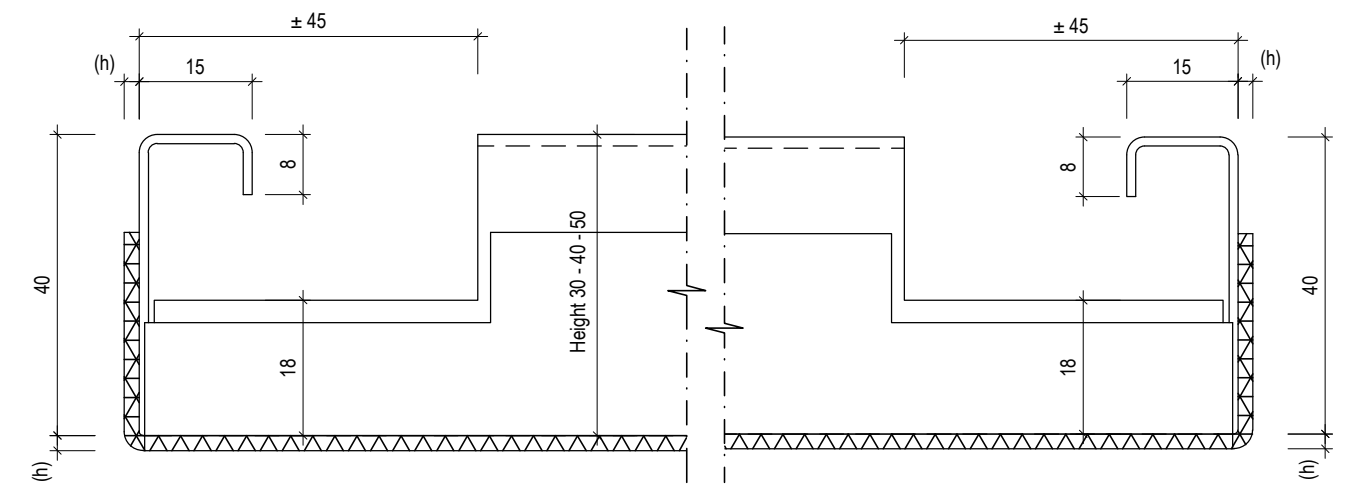
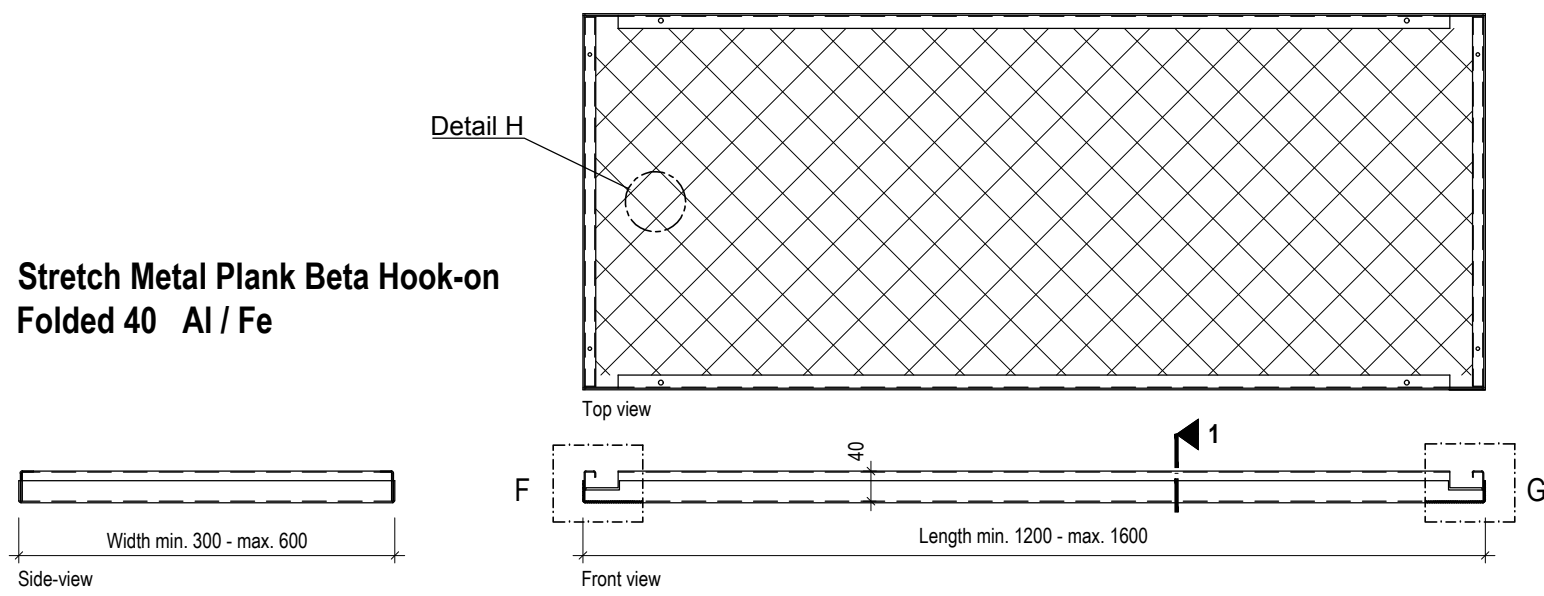

Detail F scale 1:1

Detail G scale 1:1

**Stretch Metal Plank Beta Hook-on
Folded 30 Al / Fe**

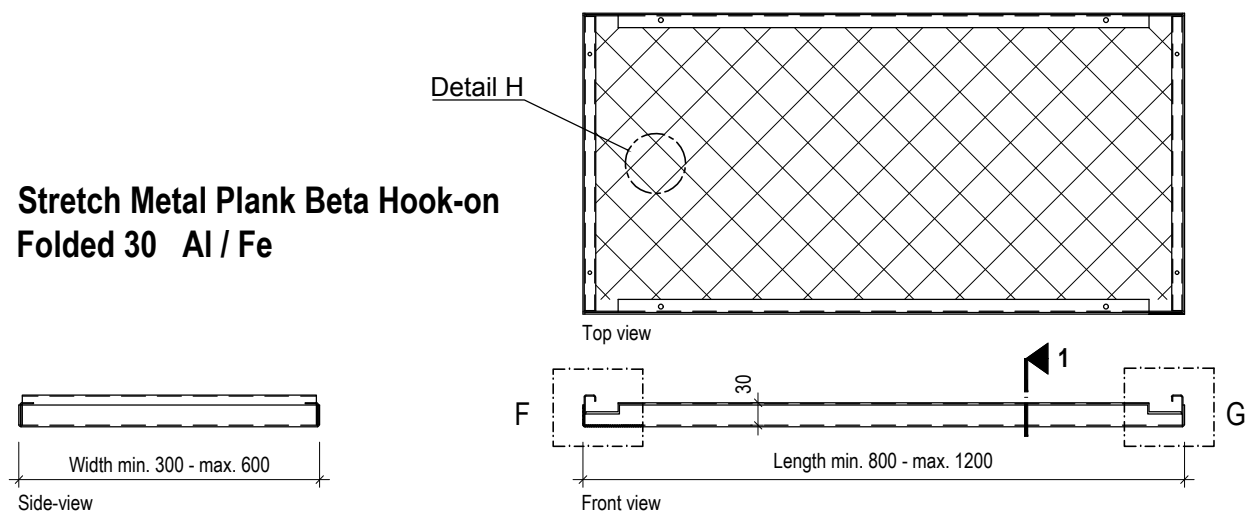

Drwg.No. C-i-SMe-PI-Beta Hook on Safetyloop Folded 2D_Planks	Date: 19.08.2019	Scale: 1:10
	Size: A3	Rev: -
Subject: Ceiling Interior Stretch Metal Planks Beta Hook on Safetyloop Folded		

Z-PROFILE 40 Fe

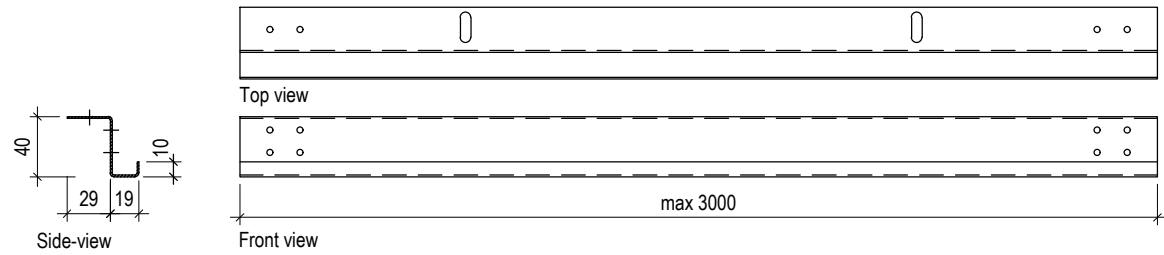

Z-PROFILE SPLICE 40

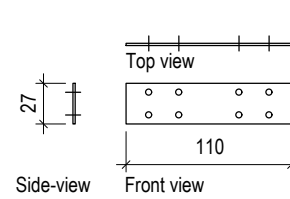

UPPER NONIUS HANGER
Length: 150, 300, 500, 1000, 1500, 2000mm

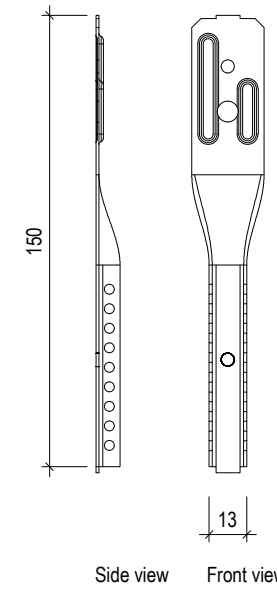

LOWER NONIUS HANGER

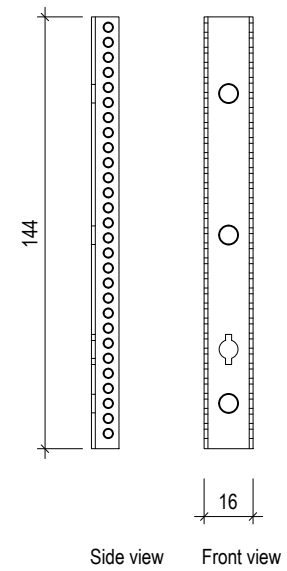

PRIMARY PROFILE Fe

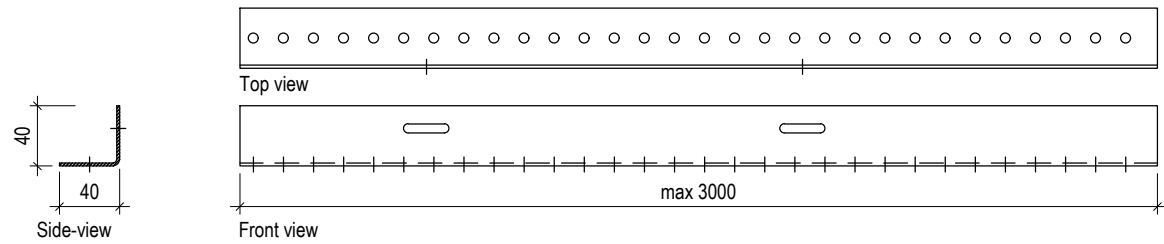

EDGE-PROFILE Al / Fe

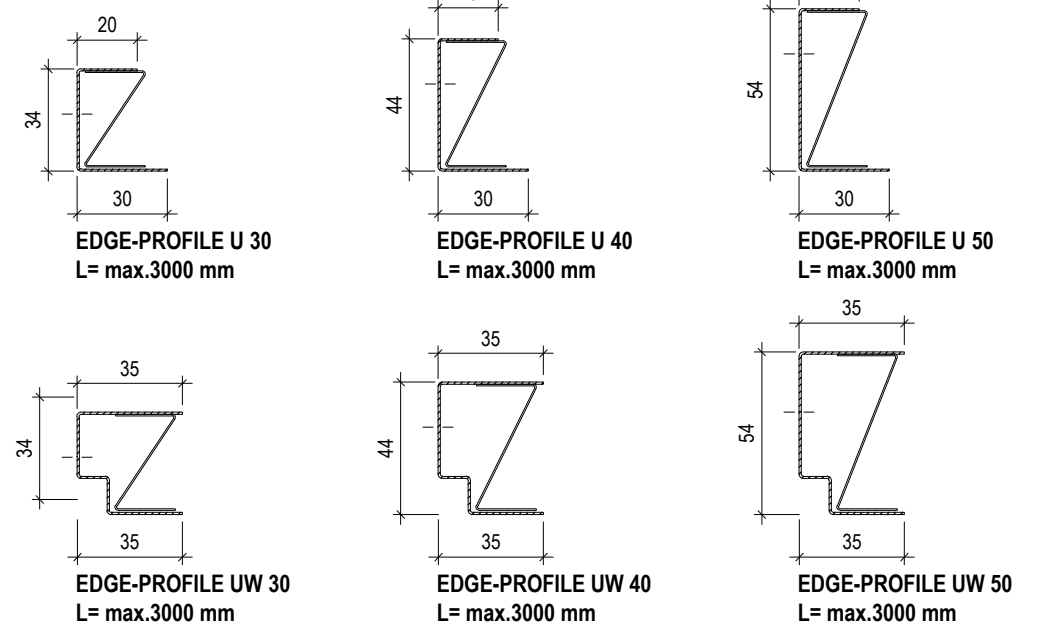

SAFETY LOOP PROFILE Fe

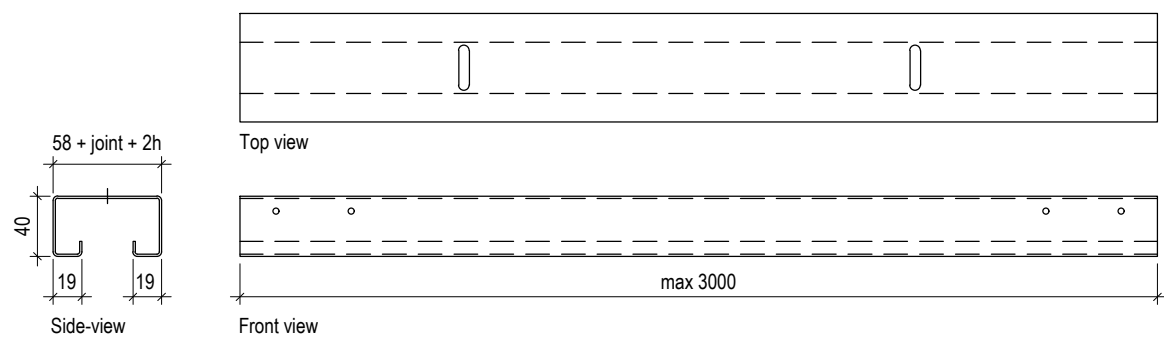

SAFETY LOOP LOCKING PLATE 72

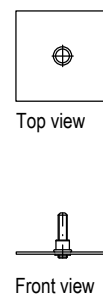

SAFETY LOOP SPLICE 72

