

spans fixation see the table and graph in the brochure

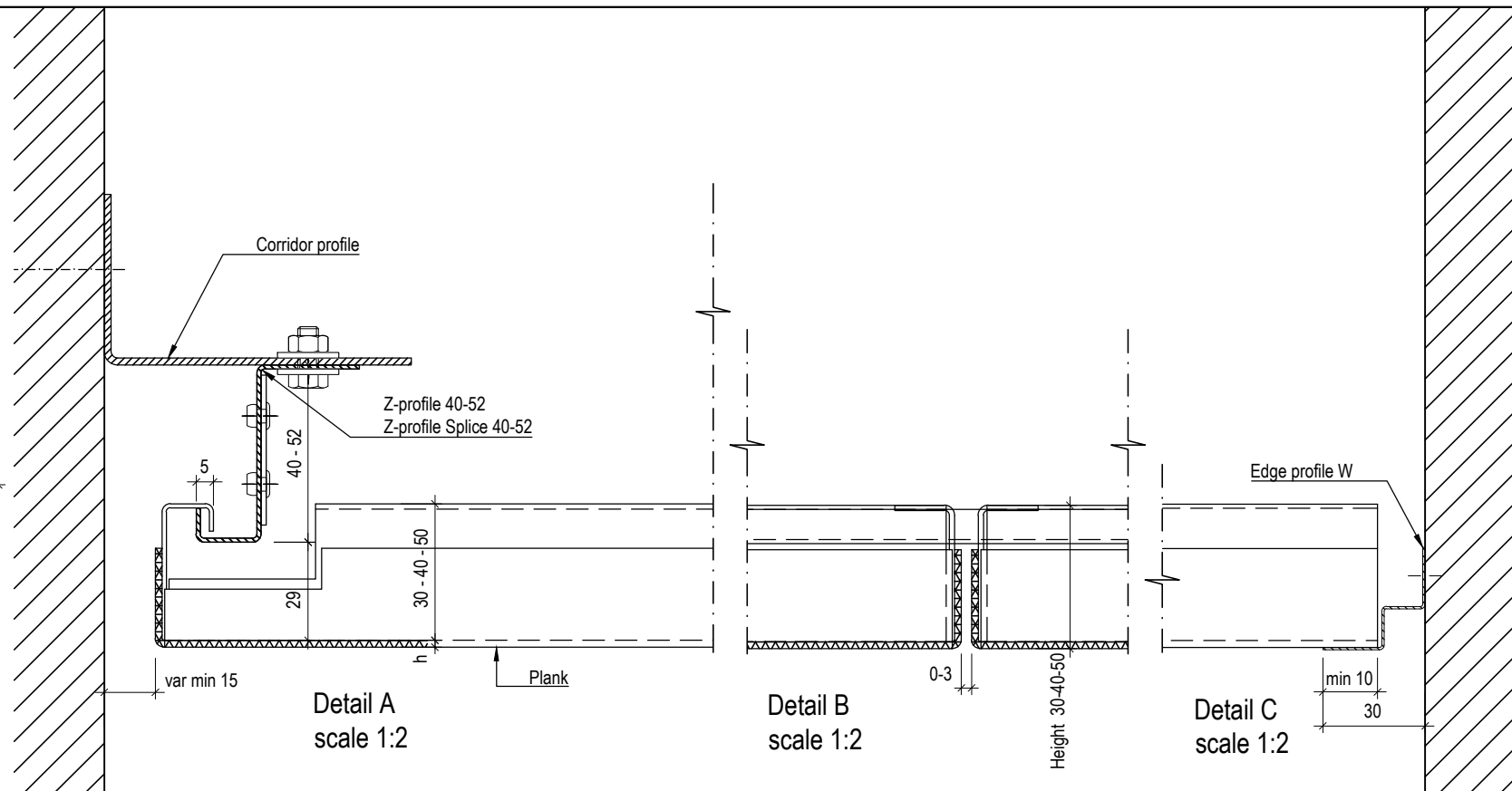

Detail A scale 1:2

Detail B scale 1:2

Detail C scale 1:2

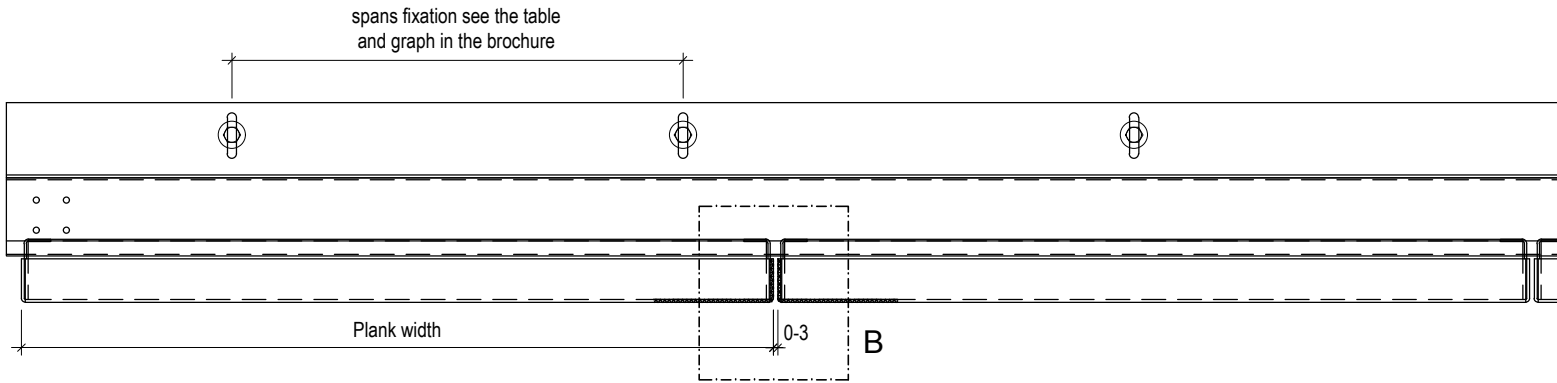
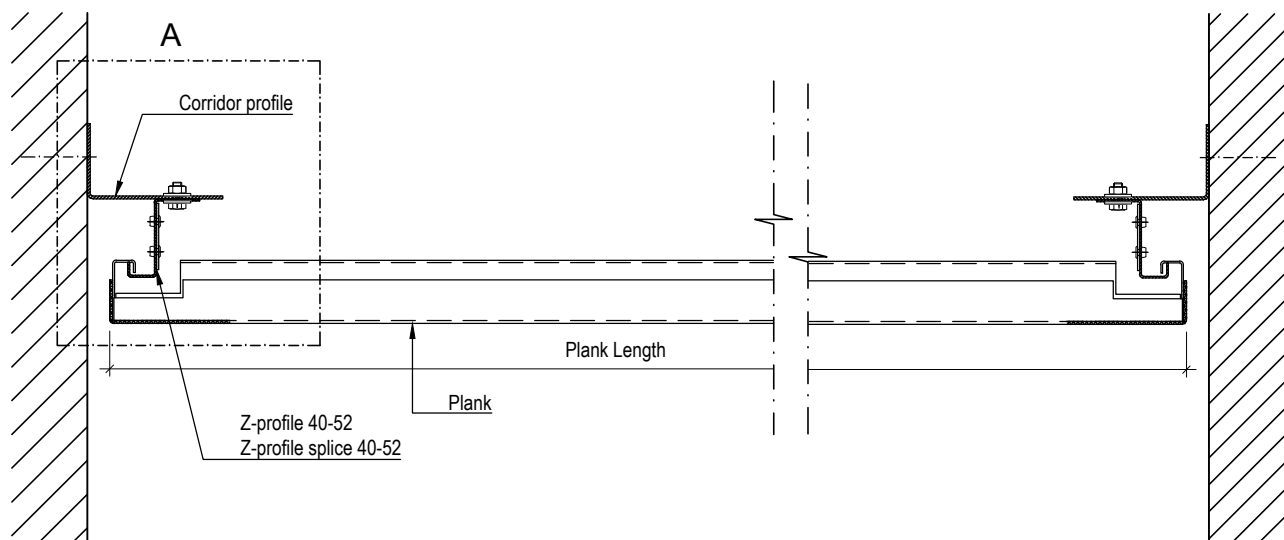

* -



Drwg.No. C-i-SMe-PI-Beta -Hook-on Singular Folded -2D_Application A	Date: 19.08.2019	Scale: 1:5
	Size: A3	Rev: -
Subject: Ceiling Interior Stretch Metal Planks Beta Hook on Singular Folded		

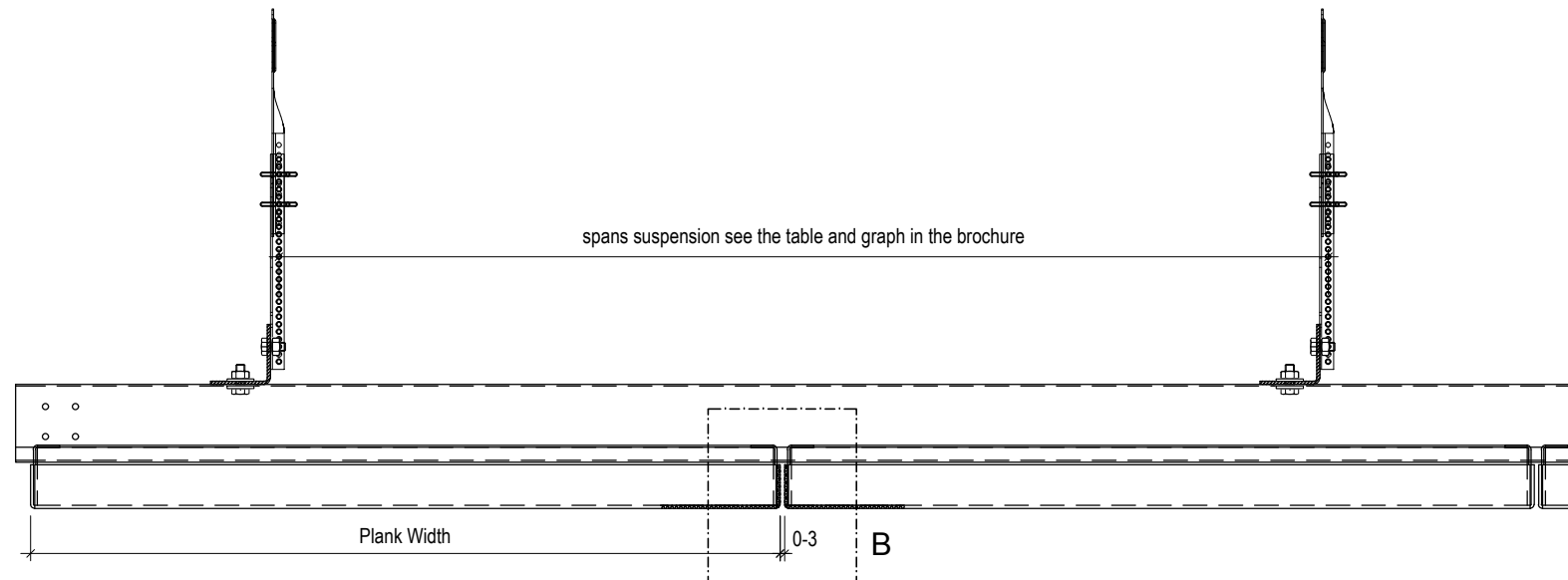
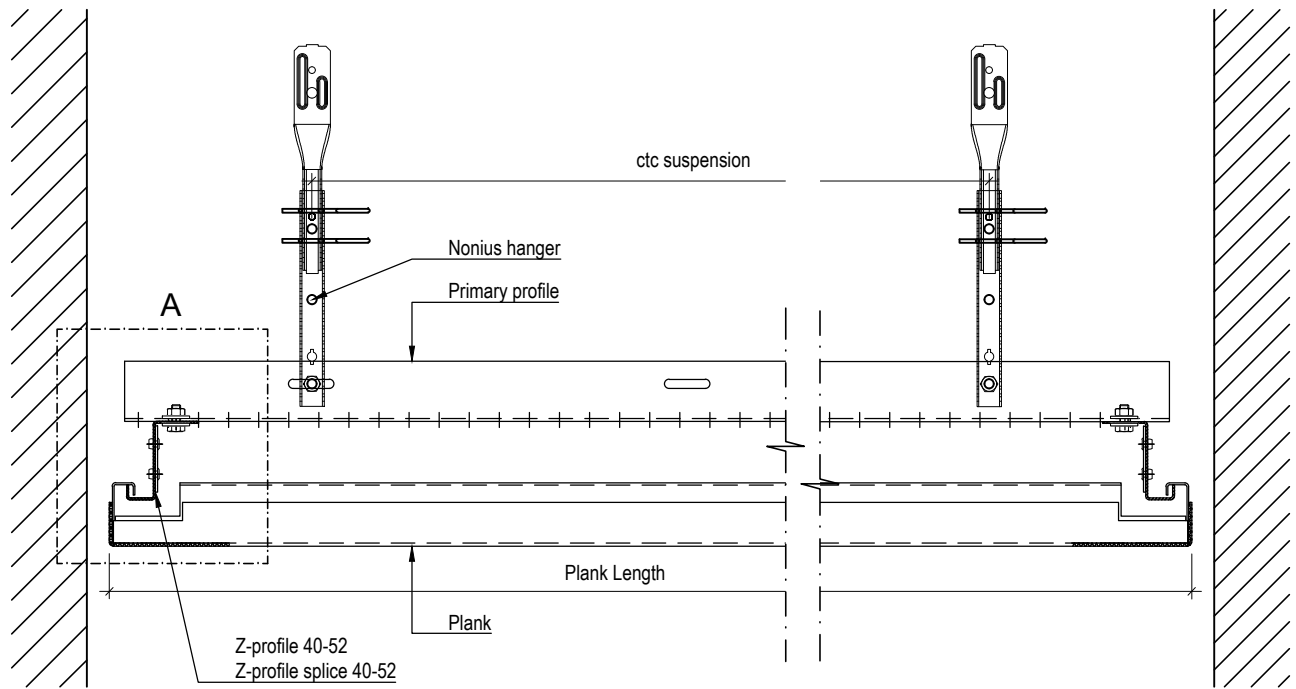
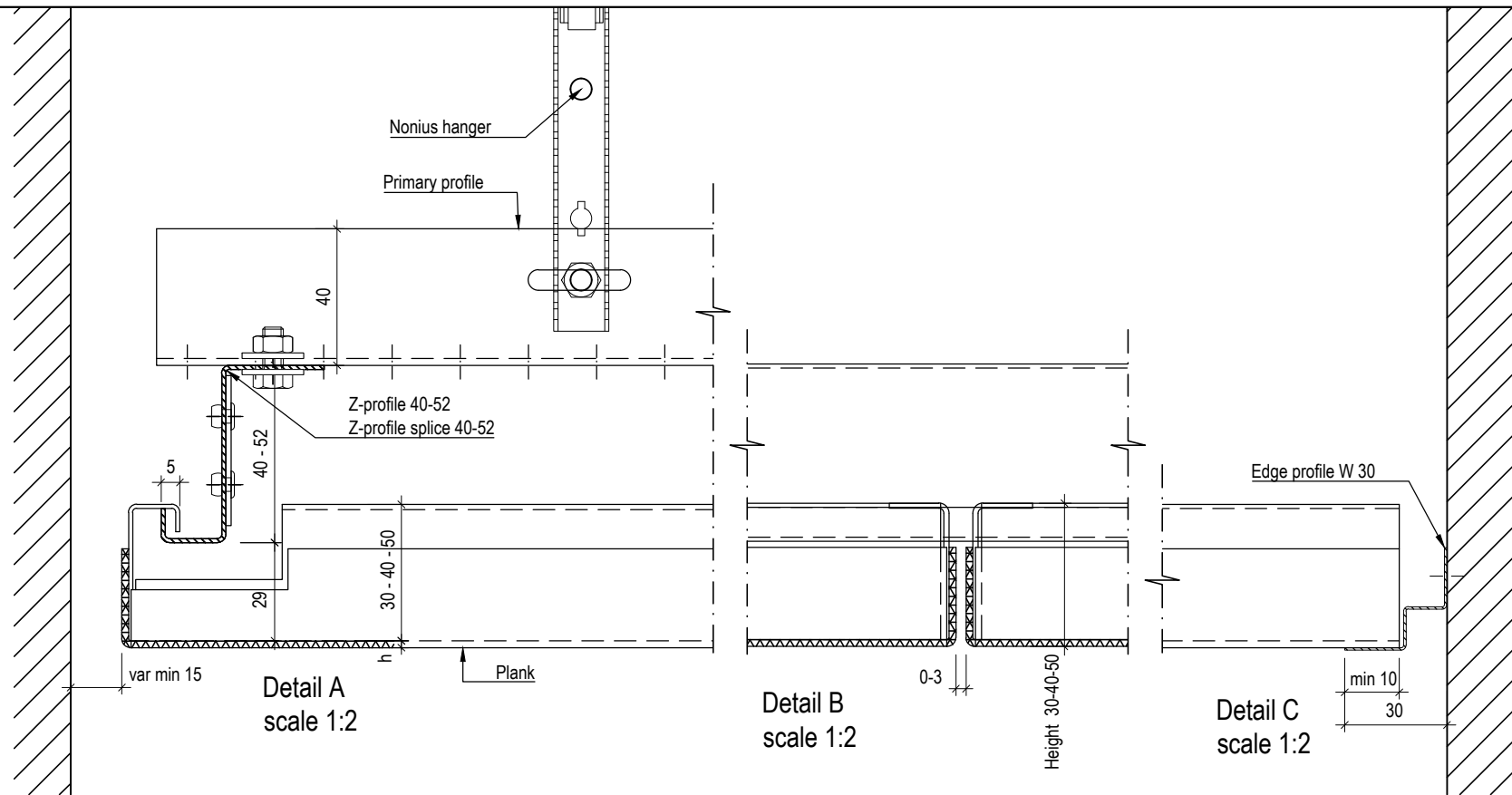
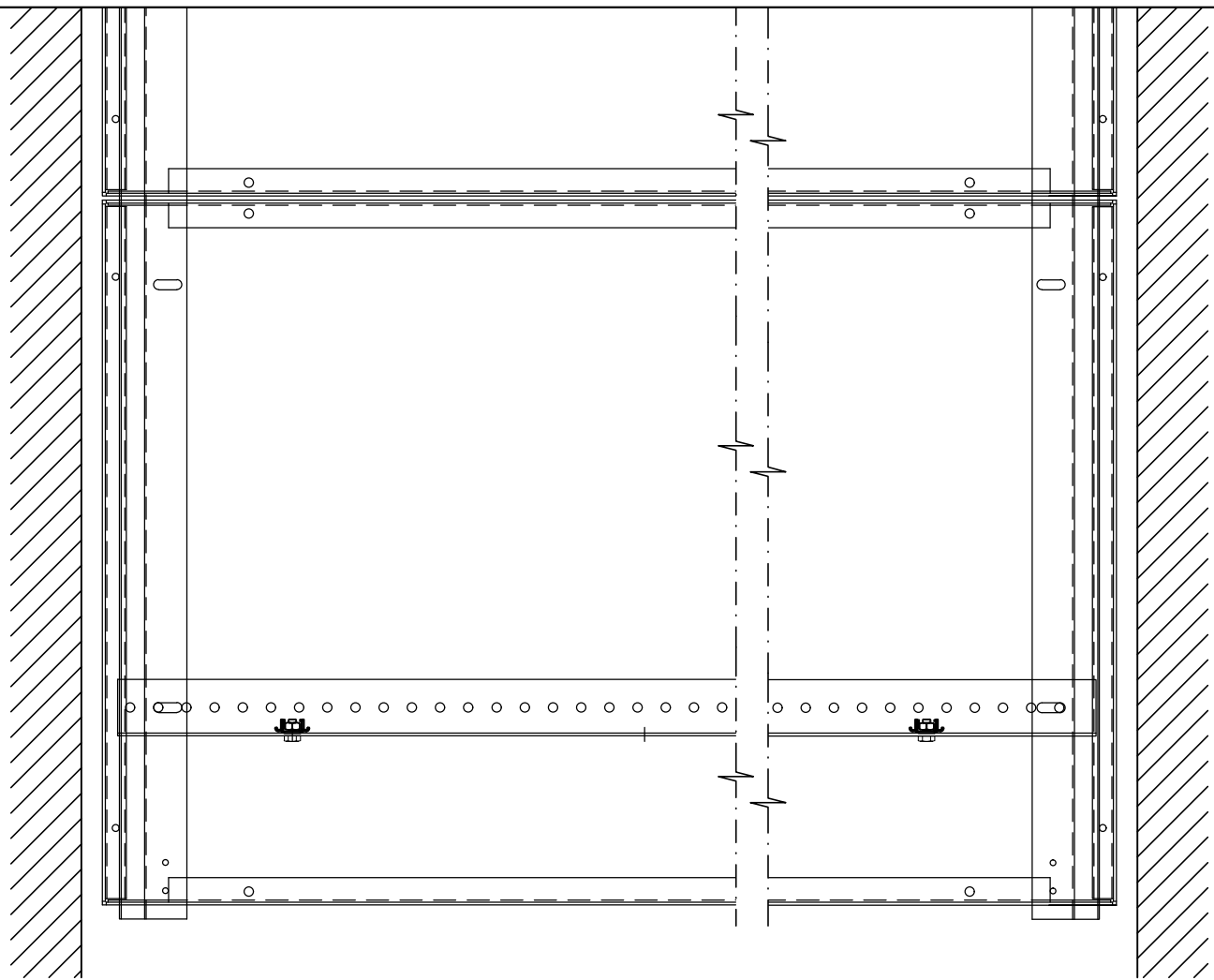

* -

HunterDouglas 
Architectural

Drwg.No. C-i-SMe-PI-Beta -Hook-on Singular Folded -2D_Application B	Date: 19.08.2019	Scale: 1:5
	Size: A3	Rev: -
Subject: Ceiling Interior Stretch Metal Planks Beta Hook on Singular Folded		

**Stretch Metal Plank Beta Hook-on
Folded 50 Al / Fe**

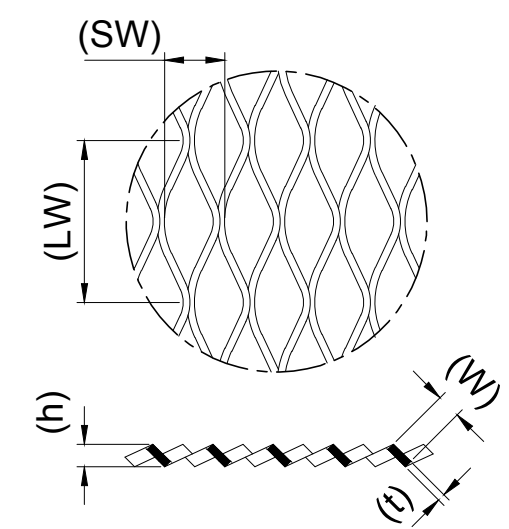
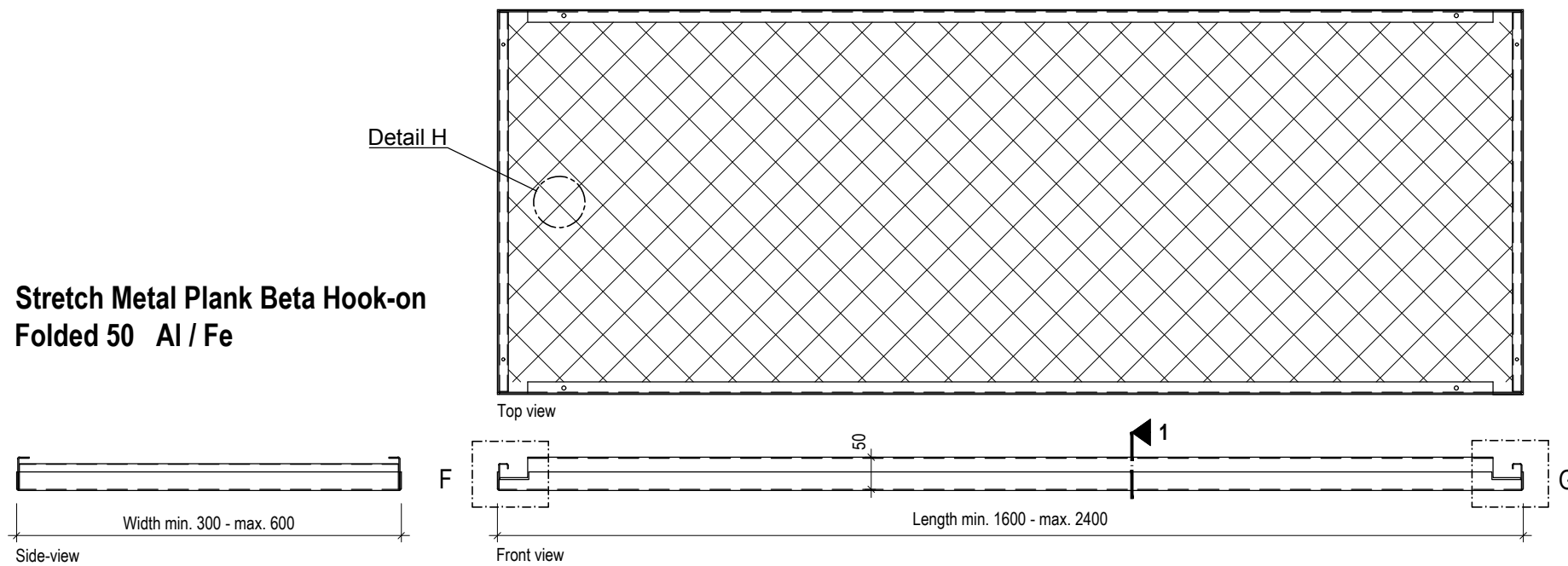

Detail H scale -:-
Orientation stretch metal
For dimensions see brochure

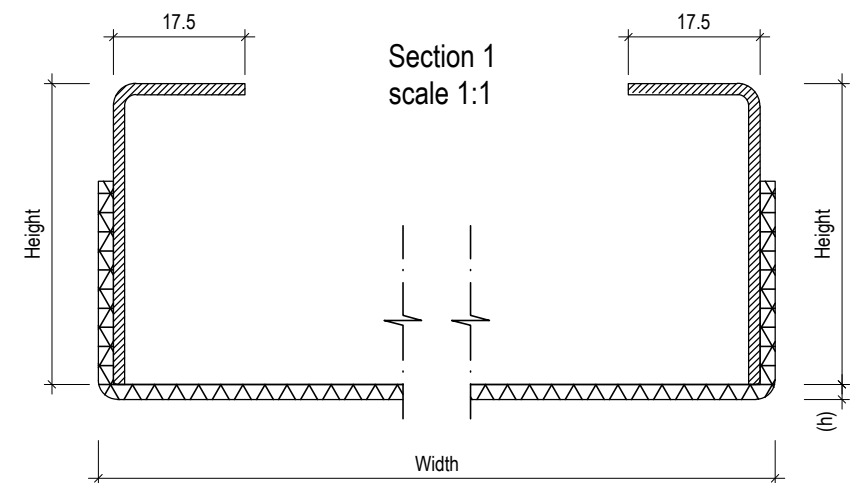

Width from	Width to	Length from	Length to	Height
300	600	800	1200	30
300	600	1200	1600	40
300	600	1600	2400	50

**Stretch Metal Plank Beta Hook-on
Folded 40 Al / Fe**

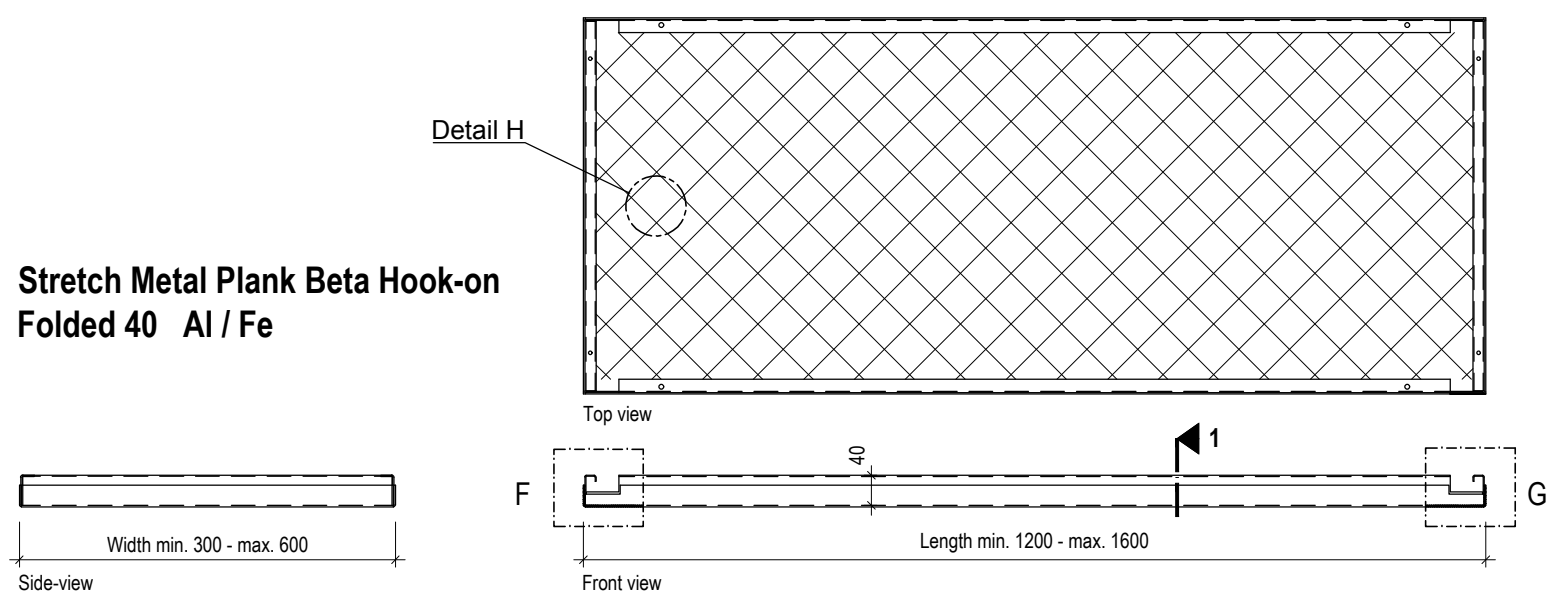

**Stretch Metal Plank Beta Hook-on
Folded 30 Al / Fe**

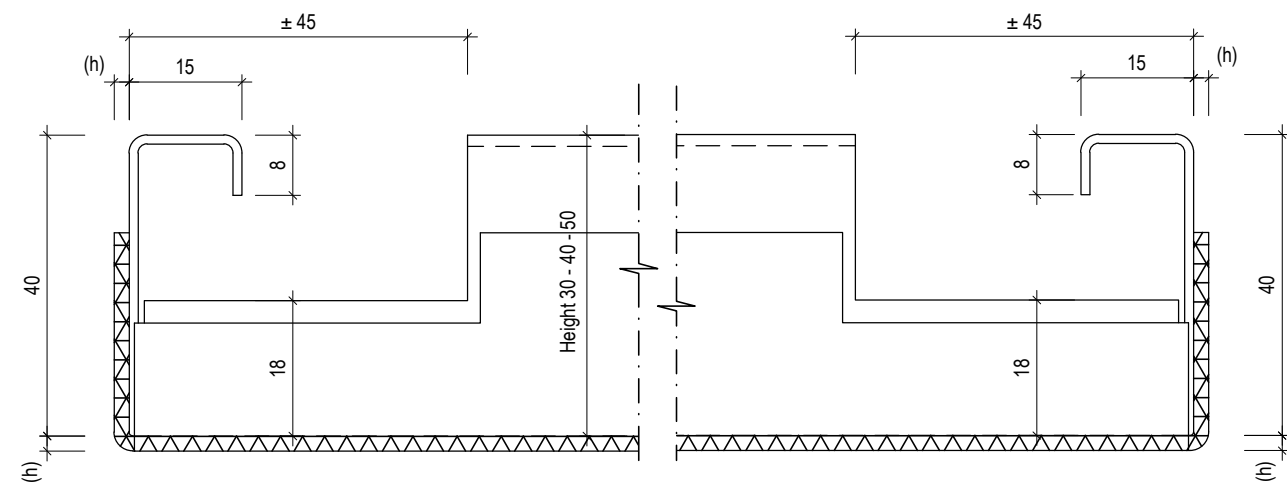
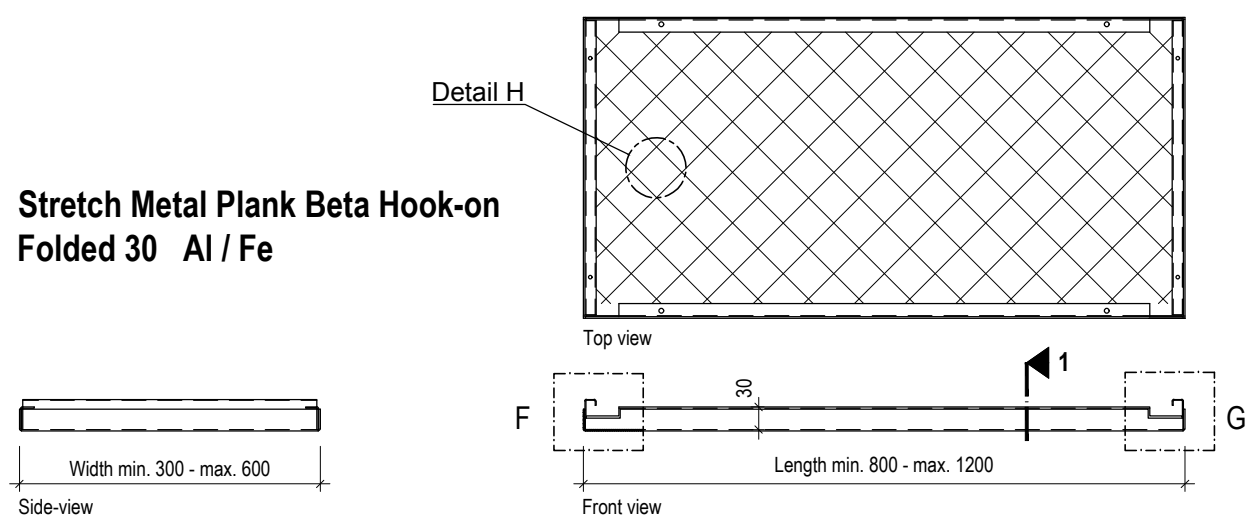

Detail F scale 1:1

Detail G scale 1:1



Drwg.No. C-i-SMe-PI-Beta -Hook-on Singular Folded -2D_Planks	Date: 19.08.2019	Scale: 1:10
	Size: A3	Rev: -
Subject: Ceiling Interior Stretch Metal Planks Beta Hook on Singular Folded		

Z-PROFILE 52 Fe

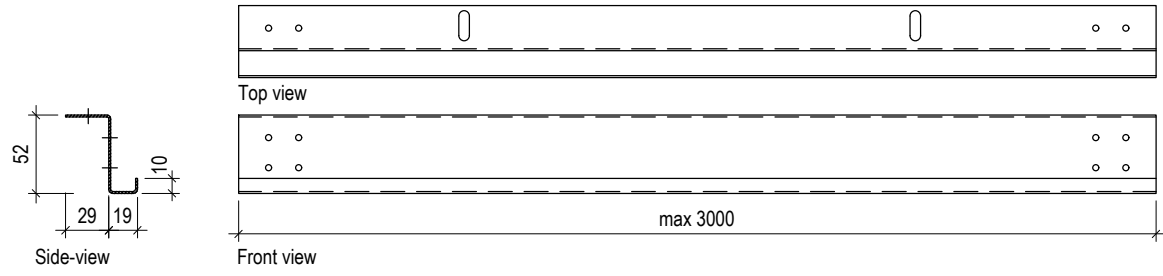

Z-PROFILE 40 Fe

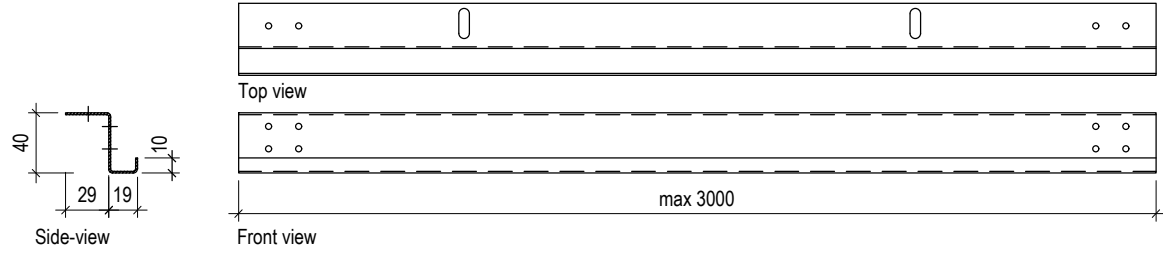

PRIMARY PROFILE Fe

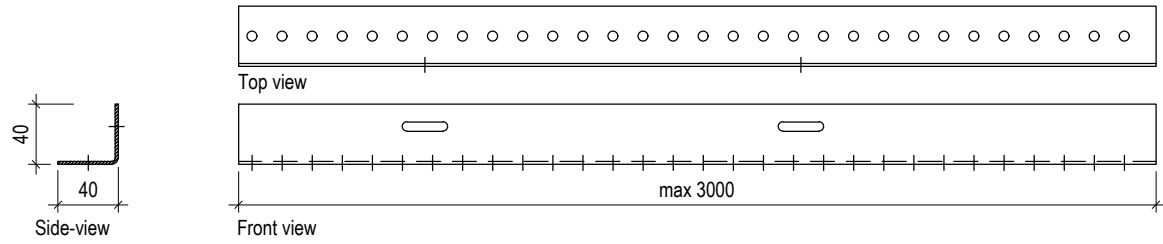

CORRIDOR PROFILE Fe

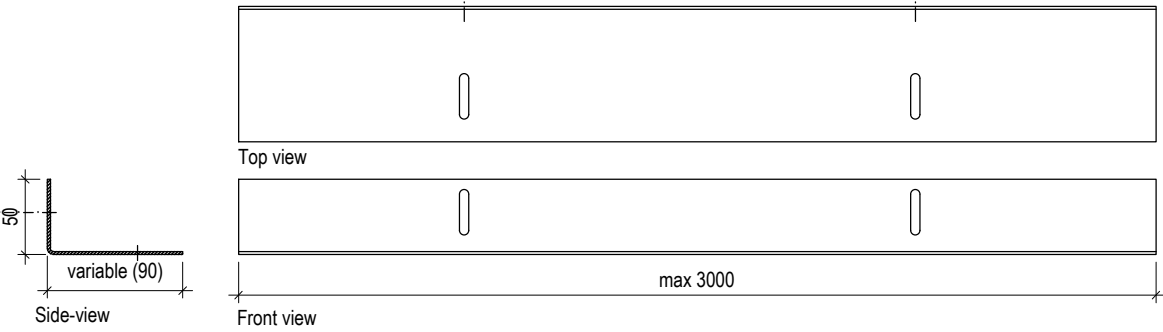

Z-PROFILE SPLICE 52

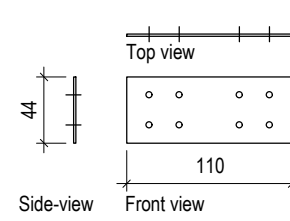

Z-PROFILE SPLICE 40

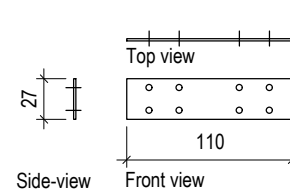

UPPER NONIUS HANGER
Length: 150, 300, 500, 1000, 1500, 2000mm

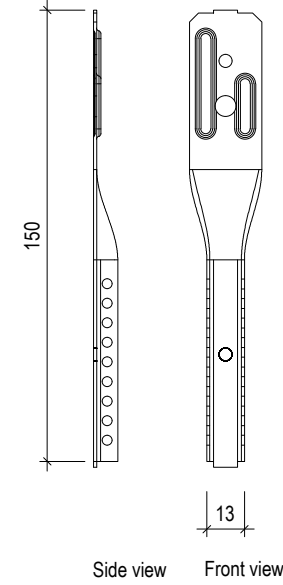

LOWER NONIUS HANGER

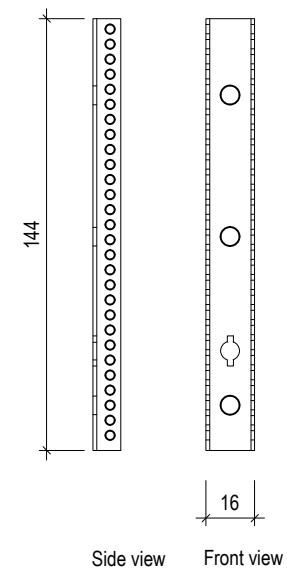

EDGE-PROFILE AL / Fe

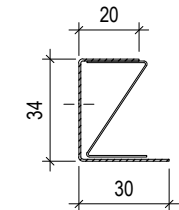

EDGE-PROFILE U 30
L= max.3000 mm

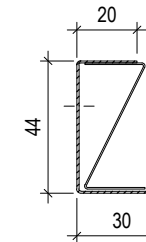

EDGE-PROFILE U 40
L= max.3000 mm

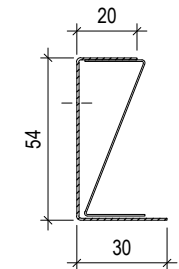

EDGE-PROFILE U 50
L= max.3000 mm

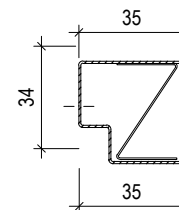

EDGE-PROFILE UW 30
L= max.3000 mm

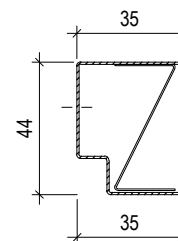

EDGE-PROFILE UW 40
L= max.3000 mm

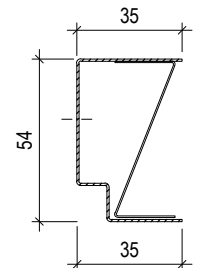

EDGE-PROFILE UW 50
L= max.3000 mm

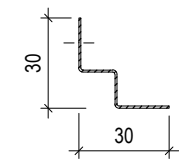

EDGE-PROFILE W 30
L= max.3000 mm

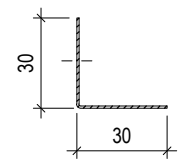

EDGE-PROFILE L 30
L= max.3000 mm



LOCKING-PROFILE 30
L= max.1160 mm



LOCKING-PROFILE 40
L= max.1160 mm



LOCKING-PROFILE 50
L= max.1160 mm